

Status: 03/2020



Products need labeling
Label printers
for industrial applications



a8+, XD4T, XC
Made in Germany

Label printers for industrial applications

They fit with a wide range of applications.

They have been developed with focus on easy and convenient operation and high reliability.

The print mechanics and the chassis are made of high-quality materials and perfectly match in terms of shape and function.

A large number of peripherals and software enable customer-specific solutions.

Whether they are operated in stand-alone mode, in a PC application or within a network – the rugged **A8+** printers and the **X series** are always up to the mark.

Sample applications

Label printer XD4T

Double-sided printing, for example textile labels, shrink tubes and continuous materials



Label printers XC4, XC6

Two-color printing, for example warning labels compliant to GHS



Label printer A8+

Cardboard and pallet labels up to A4 format



Label printer A8+, the extra-wide one

1.1



For pallet and drum labels up to a width of A4

Label printer		A8+
Printable resolution	dpi	300
Print speed	up to mm/s	150
Print width	up to mm	216

Details



1 Large graphic display

White backlight provides good readability.

2 Ribbon holder

The three-part tightening axles enable the ribbon to be quickly and easily exchanged.

3 Simple adjustment

The print head is pressed on by three plungers: One is fixed at the inner side, another is set in centered position and the third is set at the outer label margin.

4 Periphery connection

Additional modules are quick and easy to connect. All peripheral devices are plugged to the printer with the help of two pins and are fixed with a screw.

5 Rugged metal chassis

made of cast aluminum. Basis to assemble all the units

6 Roll holder

picking up core diameters of at least 38 mm (76 mm adapters for a better label winding are included in the delivery). The spring-mounted margin stop with a screw cap enables constant tension during material feed and therefore improves the accuracy of the imprint.

Label printer XD4T for double-sided printing



It prints on both sides of textile tapes, cardboard labels, pressed tubes continuous or ready-for-use, as well as on endless materials made of plastic, paper or cardboard. The ribbon separates from the materials with the help of a draw roller that also improves the accuracy of the imprint.

No print head adjustment necessary with different material widths

Print rollers provided for slim and thin materials

Label printers		XD4T
Printable resolution	dpi	300
Print speed	up to mm/s	125
Print width	up to mm	105.6

Accessories



Cutter CU4

Paper labels, self-adhesive labels, cardboard, textile and plastic materials as well as shrink tubes can be cut.

Perforation cutter PCU4

In addition, the materials can be perforated before they are manually separated.



Stacker ST4 M with cutter

The printed materials are cut and stacked. If the maximum stack height is reached, printing is interrupted. Even stiff or curved materials can be processed. We recommend to have these applications tested at our premise.

Details

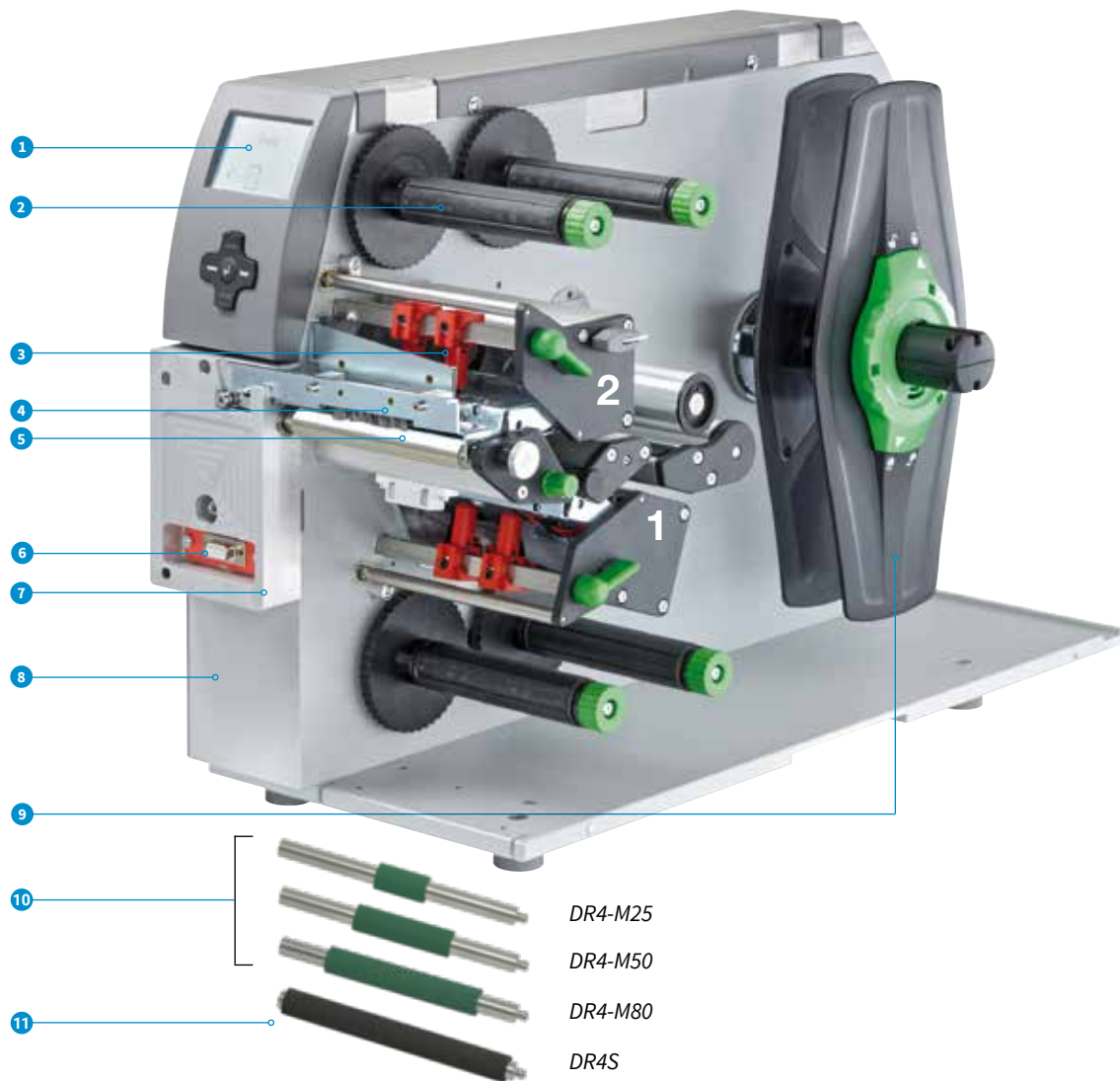

1 Large graphic display

White backlight provides good readability.

2 Ribbon holder

The three-part tightening axes enable the ribbon to be easily inserted. A preprinted ruler simplifies the adjustment.

3 Plungers

The print head is pressed on by two plungers. As the materials are centre-guided in the device, no print head setting or adjustment is necessary.

4 Antistatic brush

Particularly with plastic materials the electrostatic charge is discharged after printing.

5 Material guide

The material guide just in front of the print roller provides accurate imprint. The material width is adjusted with a spindle.

6 Periphery connection

Additional modules are quick and easy to connect. All peripheral devices are plugged to the printer with the help of two pins and are fixed with a screw.

7 Separator

primarily if continuous or textile materials as well as shrink tubes are processed. At high heat energy the ribbon can stick with the textile tape. A roller reliably separates the material from the ribbon.

8 Rugged metal chassis

made of cast aluminum. Basis to assemble all the units

9 Roll holder

picking up core diameters of at least 38 mm (76 mm adapters for a better label winding are included in the delivery). The material roll automatically centers when setting the margin stop. In case of core diameter 100 mm, an adapter is recommended.

10 Slim print rollers DR4-M

In order to achieve an accurate imprint with slim materials and ribbons, also slim print rollers are needed. These prevent from print roller wear, print head contamination and errors during material feed. Coating: synthetic rubber

11 Print roller DRS

It has an extra long service life at a higher imprint tolerance. Coating: silicone

Label printers XC for two-color printing

1.3



Two print units are arranged one behind the other to achieve simultaneous printing with two colors on one label.

Ribbon-saver mechanism on one print head

Compliant to the GHS regulations for classification and labeling

Picking up large label rolls with up to 300 mm diameter

Label printer		XC4
Printable resolution	dpi	300
Print speed	up to mm/s	125
Print width	up to mm	105.6

1.4



Label printer		XC6
Printable resolution	dpi	300
Print speed	up to mm/s	125
Print width	up to mm	162.6

We gladly assist you in the selection of proper ribbons.

Accessories



Cutter CU4

Paper labels, self-adhesive labels, cardboard, textile and plastic materials as well as shrink tubes can be cut.

Perforation cutter PCU4

In addition, the materials can be perforated before they are manually separated.



Stacker ST4 L with cutter

The printed materials are cut and stacked.

If the maximum stack height is reached, printing is interrupted.

Even stiff or curved materials can be processed.

We recommend to have these applications tested at our premise.

Common details

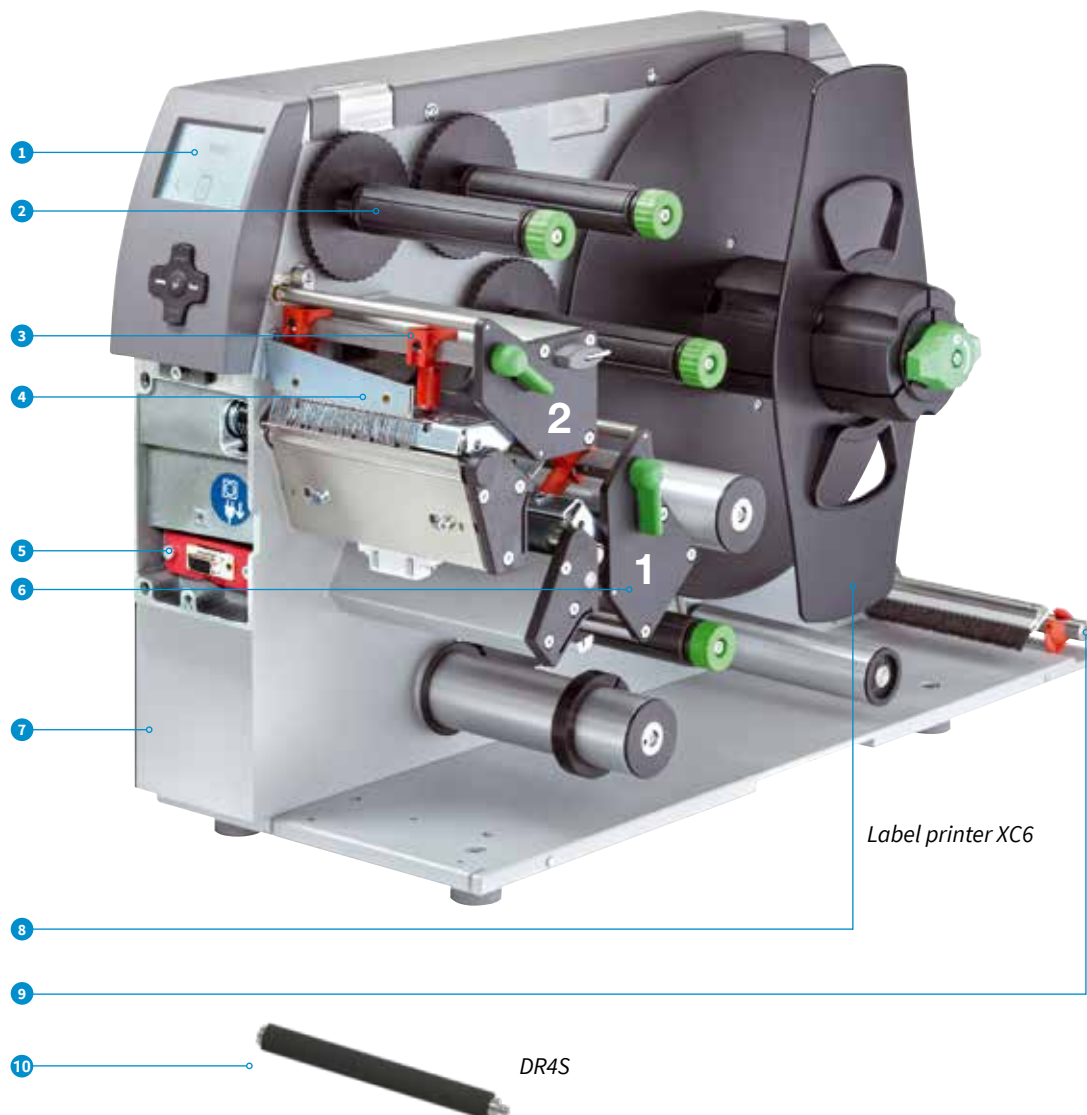

1 Large graphic display

White backlight provides good readability.

2 Ribbon holder

The three-part tightening axles enable the ribbon to be quickly and easily exchanged.

3 Plungers

One is fixed at the inner side. The second is adjusted that far to the edge of the label until a good print image is ensured.

4 Antistatic brush

Particularly with plastic materials the electrostatic charge is discharged after printing.

5 Periphery connection

Additional modules are quick and easy to connect. All peripheral devices are plugged to the printer with the help of two pins and are fixed with a screw.

6 Ribbon-saver mechanism on print head 1

to be used with labels that are only partially printed. Within unprinted areas the print head is lifted and the ribbons is stopped during label feed.

7 Rugged metal chassis

made of cast aluminum. Basis to assemble all the units

8 Roll holder

picking up label rolls up to 300 mm. With the help of the swing lever and the integrated brake labels are unwound with constant tension.

9 Fanfold guide

Fanfold labels are set behind the print unit. The guide and the additional brake ensure that they are safely fed to the print mechanics.

10 Print roller DRS

It has an extra long service life at a higher imprint tolerance. Coating: silicone

Technical data

■ Standard □ Option

Label printer		1.1	1.2	1.3	1.4	
		A8 ⁺	XD4T	XC4	XC6	
Print head						
Material feed		left-aligned	centered	left-aligned	left-aligned	
Printing method	Thermal transfer	■	■	■	■	
	Thermal direct	■	-	-	-	
Printable resolution	dpi	300	300	300	300	
Print speed	up to mm/s	150	125	125	125	
Print width	up to mm	216	105,6	105,6	162,6	
Material						
Roll	Paper, cardboard, plastics such as	■	■	■	■	
Reel	PET, PE, PP, PI, PVC, PU, acrylate, Tyvec	-	■	-	-	
	Pressed shrink tubes	-	■	-	-	
	Textile tapes	-	■	■	-	
Labels ¹⁾	Width	mm	46 - 220	10 - 110	20 - 116	46 - 176
	Height	mm	20 - 2,000	20 - 2,000	20 - 2,000	20 - 2,000
	Thickness	mm	0.05 - 0.2	0.05 - 0.8	0.05 - 0.2	0.05 - 0.2
Liner material	Width	mm	50 - 235	10 - 110	24 - 120	50 - 180
	Width	mm	50 - 235	4 - 110	-	-
Continuous material	Weight (cardboard)	up to g/m ²	300	300	-	-
	Shrink tubes	Width ready-for-use	up to mm	-	110	-
continuous		mm	-	4 - 85	-	-
Thickness		up to mm	-	1.1	-	-
Roll, reel	Outside diameter	up to mm	205	300	300	300
	Core diameter	mm	38 - 100	38 - 100	76 - 100	76 - 100
	Winding		outside or inside			
Ribbon²⁾						
Ink side		outside or inside				
Roll diameter	up to mm	72				
Core diameter	mm	25				
Variable length	up to m	360				
Width	up to mm	220	114	114	165	
Printer sizes and weights						
Width x Height x Depth	mm	352 x 274 x 446	248 x 395 x 554	248 x 395x 554	358 x 395 x 554	
Weight	kg	15	21	22	24	
Label sensor with position indication						
Gap sensor for		labels, punch marks or print marks in transparent materials and end of material				
Reflective sensor from below or top (option) for		print marks in not transparent materials and end of material				
Distance sensor	to locating edge	mm	5 - 53	-	5 - 53	
	from centre to the left	mm	-	0 - 53	-	
Electronics						
Processor 32 bit clock rate	MHz	266				
Main storage (RAM)	MB	64				
Data storage (IFFS)	MB Flash	8				
Slot for	CompactFlash Type I	■				
	WLAN card	■				
Battery buffer for real-time clock		■				
Acoustic error signal		■				
Interfaces						
RS232C		■		-		
USB 2.0 Hi-speed slave to connect a PC		■		■		
Ethernet 10/100 Mbit/s		LPD, RawIP printing, FTP, DHCP, HTTP, SMTP, SNMP, TIME, Zeroconf, mDNS, SOAP				
RS422/RS485		□		-		
Periphery connection		■		■		
WLAN 802.11b/g, WEP/WPA-PSK (TKIP)		□		□		
2 x USB host for		Service Key, USB memory stick, keyboard, barcode scanner, external operation panel				
Operating data						
Power supply		100 - 240 VAC, 50/60 Hz, PFC				
Power consumption		100-300 W, depending from the type of device				
Temperature / humidity	Operation	+5 - 40°C / 10 - 85 % not condensing				
	Storage	0 - 60°C / 20-80 % not condensing				
	Transport	-25 - 60°C / 20-80 % not condensing				
Approvals		CE, FCC, CB, cULus, CCC				

¹⁾ Limitations may apply to small labels, thin materials or strong adhesives. Critical applications need to be tested.

²⁾ The ribbon should at least correspond with the width of the liner material.

Technical data

■ Standard □ Option

Operation panel	
	Graphic LCD display Width 60 mm, height 40 mm Four lines of text, approx. 20 characters per line
Buttons / LED	Pause, Feed, Cancel, Menu, Enter 4 x cursor
Setup options	
	Digital or analog clock Time Device settings Date Printing parameters Interfaces Language settings Security
Status display	
	Data reception Clock WLAN Calendar Ethernet abc debug Memory in use Input buffer Print head temperature Ribbon remaining Memory card access
Monitoring	
	End of ribbon End of label web Print head open Final cutter position not reched
Test routines	
System diagnostics	when device is switched on, including print head detection
Brief status display, status printout	Fonts list Test grid Device overview Label profile WLAN status Monitor mode PPP status
Status reports	- Printout of device settings, for example print lengths and running times - Device status request via software command - Display information of, for example, network error, missing link, barcode error, etc.
Fonts	
Font types internally provided	5 bitmap fonts: 3 vector fonts: 12 x 12 dots Swiss 721 16 x 16 dots Swiss 721 Bold 16 x 32 dots Monospace 821 OCR-A OCR-B
to be stored	TrueType fonts
Character sets	Windows-1250 to -1257 DOS 437, 737, 775, 850, 852, 857, 862, 864, 866, 869 EBC DIC 500 ISO 8859-1 to -10 and -13 to -16 WinOEM 720 UTF-8 MacRoman DEC MCS K018-R Western European Cyrillic Eastern European Greek Chinesisch simplified Latin Thai Hebrew Arabic
Bitmap fonts	Size in width and height 1 - 3 mm Zoom factor 2 to 10 Orientations 0°, 90°, 180°, 270°
Vector / TrueType fonts	Size in width and height 0.9 - 128 mm Variable zoom Orientation 360° in steps of 1°
Font styles	Bold, italic, underlined, outline, inverse - depending from the font type
Character spacing	variable

Graphics	
Graphic elements	Lines, arrows, rectangles, circles, ellipses; filled and filled with fading
Graphic formats	PCX, IMG, BMP, TIF, MAC, GIF, PNG
Barcodes	
Linear	Code 39, Code 93 Interleaved 2/5 Code 39 Full ASCII Ident and routing code Code 128 A, B, C of Deutsche Post EAN 8, 13 Codabar EAN/UCC 128/GS1-128 JAN 8, 13 EAN/UPC Appendix 2 MSI EAN/UPC Appendix 5 Plessey FIM Postnet HIBC RSS 14 UPC A, E, E0
2D and stacked	DataMatrix EAN-DataMatrix QR code PDF 417 Micro PDF 417 GS1 Data Bar Aztec Codablock F UPS Maxicode RSS 14 truncated, limited, stacked, stacked omni-directional All codes are variable as regards height, modular width and ratio; orientations 0°, 90°, 180°, 270° optional check digit, plain text printout and start / stop code depending from the type of code
Software	
Label software	cablabel S3 Lite ■ cablabel S3 Viewer ■ cablabel S3 Pro □ cablabel S3 Print □
Running also with	CODESOFT NiceLabel BarTender
Stand-alone operation	■
WHQL certified Windows printer drivers for	Windows Vista Server 2008 Windows 7 Server 2008 R2 Windows 8 Server 2012 Windows 8.1 Server 2012 R2 Windows 10 Server 2016 Server 2019
Apple Mac OS X printer drivers ³⁾	from version 10.6 ■
Linux printer drivers ³⁾	from CUPS 1.2 ■
Programming	Printer language JScript ■ abc Basic Compiler ■
Integration	SAP ■ Database Connector ■
Administration	Printer control ■ Configuration in Intranet and Internet ■ Network Manager ■













³⁾ only with label printer A8+

Overview of accessories

○ Possible □ Option

Pos.	Device add-ons	1.1 A8 ⁺	1.2 XD4T	1.3 XC4	1.4 XC6
Extra equipment					
2.3	Print rollers DR4-M25, -M50, -M80	-	□	-	-
2.4	Print roller DR4S	-	□	□	□
2.5	Label sensor	□	-	-	-
2.6	Adapter 100	□	□	-	-
2.7	CompactFlash memory card	□	□	□	□
2.8	External operation panel	□	□	□	□
2.9	Pause adapter PS7	□	-	-	-
Interfaces					
3.2	RS422/RS485	□	-	-	-
3.3	Label selection - I/O box	□	□	□	□
3.4	WLAN 802.11b/g	□	□	□	□
Connecting cable					
4.1	Connecting cable RS232C, 9/9 pin, length 3 m	□	□	□	□
Label cutting, perforating, stacking					
5.1	Cutter CU	□	□	□	□
5.3	Perforation cutter PCU4	-	□	○	-
5.4	Stacker ST4 L with cutter	-	-	□	-
	Stacker ST4 M with cutter	-	□	-	-
Label rewinding, unwinding					
6.1	External rewinder ER	□	□	□	□
6.3	Adapter kit for rewinders, unwinders with A8 ⁺	□	-	-	-
6.4	Adapter kit for rewinders, unwinders with XC4, XC6	-	-	□	□

Accessories - extra equipment, interfaces, connecting cable

Extra equipment									
2.3	 <p>Print roller DR4-M25 Material width up to 25 mm Synthetic rubber coating for accurate imprint</p>								
	 <p>Print roller DR4-M50 Material widths 20 to 50 mm Synthetic rubber coating for accurate imprint</p>								
	 <p>Print roller DR4-M80 Material width up to 80 mm Synthetic rubber coating for accurate imprint</p>								
2.4	 <p>Print roller DR4S Material width up to 120 mm Silicone coating for an extra long service life at a higher imprint tolerance</p>								
2.5	 <p>Label sensor Reflective from top</p>								
2.6	 <p>Adapter 100 to pick up label rolls with core diameter 100 mm and outside diameters larger than 180 mm</p>								
2.7	 <p>Memory card CompactFlash Typ I</p>								
2.8	 <p>External operation panel If the operation panel is no longer accessible after the printer has been installed in a plant, an external one can be additionally added. A slot to connect a CompactFlash memory card Type I as well as a host interface are provided.</p>								
2.9	 <p>Pause adapter PS7 for printing in a reserve loop. The print job is stopped by the Pause signal. The label that is currently printed will be completed.</p> <p>I/O interface</p> <table border="0"> <tr> <td>Inputs:</td> <td>Outputs:</td> </tr> <tr> <td>Pause</td> <td>Print job missing</td> </tr> <tr> <td>External errors</td> <td>Printer not ready</td> </tr> <tr> <td></td> <td>Printing started</td> </tr> </table>	Inputs:	Outputs:	Pause	Print job missing	External errors	Printer not ready		Printing started
Inputs:	Outputs:								
Pause	Print job missing								
External errors	Printer not ready								
	Printing started								
Interfaces									
3.2	 <p>RS422/RS485 1,200 to 230,400 baud/8 bit</p>								
3.3	 <p>Label selection - I/O box Up to 16 labels per box can be selected from the memory card by a master control, e.g. PLC. Two boxes can be connected. The I/O box allows simple PLC control processes with four inputs and outputs each via abc programming.</p>								
3.4	 <p>WLAN 802.11b/g</p>								
Connecting cable									
4.1	 <p>Connecting cable RS232C 9/9 pin, length 3 m</p>								

Accessories - label cutting, perforating, stacking



Cutter CU

Paper labels, self-adhesive labels, cardboard, textile and plastic materials as well as shrink tubes can be cut.

Technical data	Cutter		
	CU4	CU6	CU8
To be used with	XD4T, XC4	XC6	A8+
Material Width up to mm	110	180	232
Weight cardboard gr/m ²	60 - 300		
Thickness mm	0.05 - 0.8		
Cutting length from mm	5		
Gap height up to mm	2.5		
Cuts/min, without material up to	100		
Stop print job when	final cutter position not attained		



Perforation cutter PCU4

Continuous materials such as textiles or shrink tubes are perforated before they are manually separated. In addition, the materials can also be cut.

Technical data	Perforation cutter	
	PCU4	
To be used with	XD4T, XC4	
Perforating Web distance mm	0.5	
Web width mm	2.5 or 10	
Material Width up to mm	85	
Weight cardboard gr/m ²	60 - 300	
Thickness mm	0.05 - 0.8	
Cutting length from mm	5	
Gap height up to mm	2.5	
Cuts/min, without material up to	100	
Stop print job when	final cutter position not attained	



Stacker ST4 with cutter

The printed materials are cut and stacked. If the maximum stack height is reached, printing is interrupted. Limitations may apply to stiff or curved materials. We recommend to have these materials tested at our premise.

Technical data	Stacker with cutter	
	ST4 L	ST4 M
To be used with	XC4	XD4T
Material Width up to mm	20 - 110	20 - 100
Weight cardboard gr/m ²	60 - 300	
Thickness mm	0.05 - 0.8	
Cutting length from mm	20 - 150	
Gap height up to mm	1.2	
Cuts/min, without material up to	100	
Stop print job when	final cutter position not attained, stacker cover open, stack height attained	
Stack height up to mm	100	



Support table - label W x H

The support table and the protective cover are adapted to the label size. They have to be ordered separately.

Accessories - label rewinding

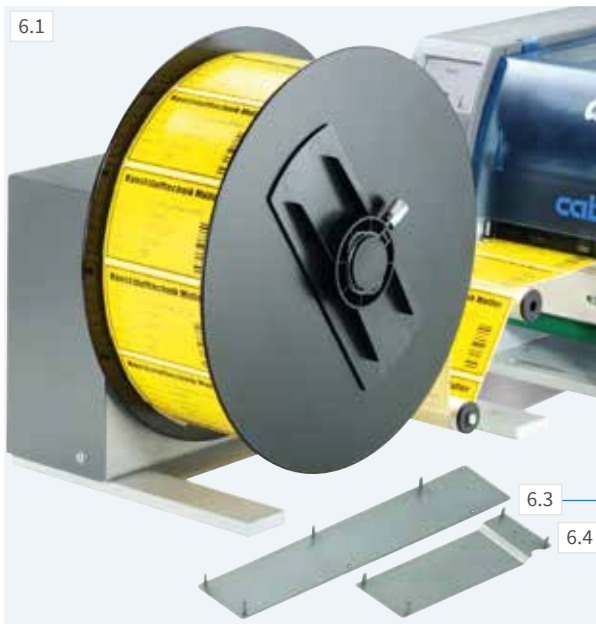

External rewinders ER4/6/8 with built-in power supply units

To be used also with external printers. Label winding outside or inside

Technical data	External rewriter			
	ER4/210	ER4/300	ER6/300	ER8/300
To be used with	XD4T, XC4	XD4T, XC4	XC6	A8+
Material width up to mm	120	120	180	235
Roll diameter up to mm	205	300	300	300
Tightening axle mm for core diameter	76			
Winding	outside or inside			
Power supply	100 - 240 V, 50/60 Hz			
Adapter kit for				
	ER8 with A8+			
	ER4, ER6 with XC4, XC6			

Label software cablabel S3

Designing, printing, administrating

cablabel S3 opens up the full potential of cab devices.

First of all, the label must be designed. Only when it comes to printing it has to be decided whether the label shall be processed on a label printer, a print and apply or marker laser system. cablabel S3 is of a modular design which makes it adaptable to requirements step by step. To support functions like native JScript programming, elements such as the JScript Viewer are embedded as plug-ins. The designer user interface and the JScript code are synchronized in real time. Special functions like the Database Connector or barcode testers can be integrated. For further information see www.cab.de/en/cablabel

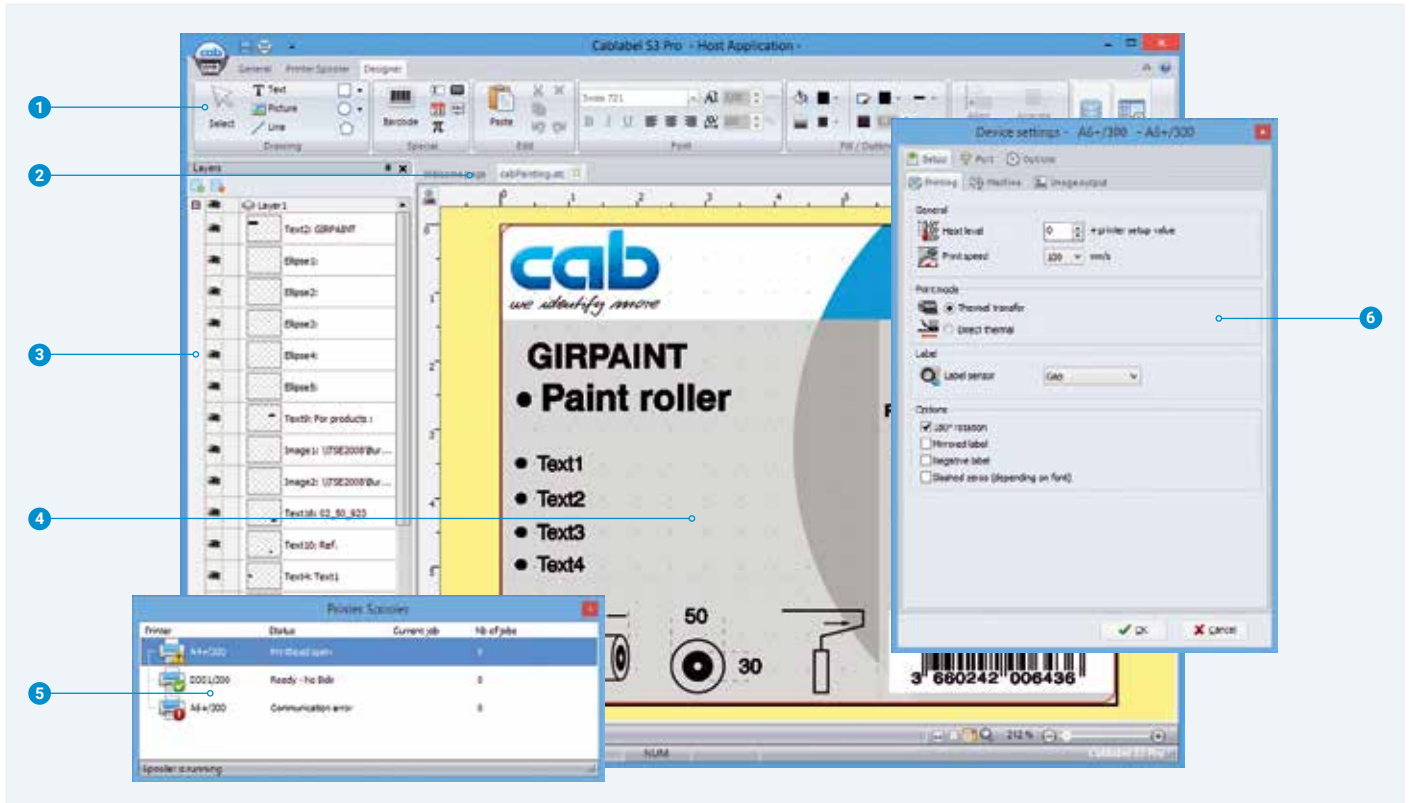

- 1 **Toolbar**
to create different label objects
- 2 **Tabs**
to quickly switch from one running label design to another
- 3 **Layers**
to administrate different label objects
- 4 **Designer**
simplifies the design and displays the label WYSIWYG
- 5 **Printer spooler**
to monitor all print jobs and the state of the printer
- 6 **Drivers**
for setting and the communication with devices

Printing in stand-alone operation

This operating mode is the printer's ability to select and print labels even when it is not connected connected to a host system.

The label has to be designed with a software such as cablabel S3 or by direct programming with a text editor on a PC. Label formats, texts, graphics as well as database contents are stored on a memory card, a USB memory stick or in the internal IFFS memory.

Only variable data are sent to the printer via a keyboard, a barcode scanner, scales or other host systems and/or recalled by the Database Connector from the host and printed.



Printer control

Drivers

To control the printer with a software other than cablabel S3, cab provides drivers in 32 / 64 bit for operating systems starting from Windows Vista, Mac OS 10.6 and Linux with CUPS 1.2.



Windows¹⁾ drivers

cab printer drivers are certified according to WHQL. They ensure optimum stability on the Windows operating system.



Mac OS X²⁾ drivers

cab provides CUPS-based printer drivers for Mac OS X applications.



Linux drivers

Linux drivers are CUPS-based.

Drivers are offered on the DVD delivered with the printer and for free download at www.cab.de/en/support

Programming



JScript

To control the printer, cab has developed the embedded programming language JScript. See manual for free download at www.cab.de/en/programming



abc Basic Compiler

In addition to JScript and as an integral part of the firmware, it allows advanced printer programming before data are sent to printout. For example, external printer languages can be replaced without interfering in the current print job. Also data from other systems such as a scale, a barcode scanner or PLC can be integrated.

Integration



Printer Vendor Program

As a partner in SAP's³⁾ Printer Vendor Program, cab has developed a replace method to enable easy control of a cab printer via SAPScript from SAP R/3. Only variable data are sent to the printer by the host. Pictures and fonts that had priorly been stored in the local memory (IFFS, memory card, etc.) are merged.

Step 1

Create a label and a replace file with cablabel S3

Step 2

Use the replace file and replace the variable data in SAPScript

Step 3

Printout from SAP

Printer administration



Configuration in Intranet and Internet

The HTTP and FTP server integrated in the printer via standard programs like a web browser or FTP clients allows printer control and configuration, firmware updates and memory card administration. Via email or SNMP, the SNMP and SMTP client datagram sends status, warning and error messages to administrators and users. Time and date are synchronized by a time server.



Network Manager

It is possible to simultaneously manage several printers within the network. Control, configuration, firmware updates, memory card administration, data synchronization and PIN administration are supported from one single location.

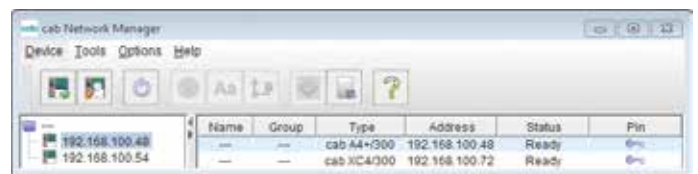

Database Connector

Printers connected to a network may directly access data from a central ODBC or OLEDB-ready database and print it on a label. While printing, data can be rewritten to the database.



¹⁾ Windows is a registered trademark of Microsoft Corporation

²⁾ MAC OS X is a registered trademark of Apple Computer, Inc.





³⁾ SAP and all corresponding logos are trademarks or registered trademarks of SAP SE

Delivery program

Pos.	Part no.	Printers
1.1	5954517.101	Label printer A8+
1.2	5959970	Label printer XD4T
1.3	5965700	Label printer XC4
1.4	5965701	Label printer XC6
Scope of delivery		
	Label printer Power cable Type E+F, length 1.8 m Connecting cable USB, length 1.8 m Instructions DE / EN	
DVD	Instructions - in more than 20 languages (A8+) - in DE / EN / FR / RS / IT (X series) Configuration manual DE / EN / FR Service manual DE / EN Spare parts list DE / EN Programming manual EN WHQL certified Windows printer drivers for Windows Vista Server 2008 Windows 7 Server 2008 R2 Windows 8 Server 2012 Windows 8.1 Server 2012 R2 Windows 10 Server 2016 Server 2019 Apple Mac OS X printer drivers DE / EN / FR (A8+ only) Linux printer drivers DE / EN / FR (A8+ only) Label software cablabel S3 Lite cablabel S3 Viewer Database Connector	

Pos.	Part no.	Wear parts
	5954072.001	Print head 4/300 dpi
	5954106.001	Print head 6/300 dpi
	5954107.001	Print head 8/300 dpi
	5954180.001	Print roller DR4
	5954245.001	Print roller DR6
	5954103.001	Print roller DR8
Pos.	Part no.	Extra equipment
2.3	5953700.001	Print roller DR4-M25
	5953701.001	Print roller DR4-M50
	5953702.001	Print roller DR4-M80
2.4	5954985.001	Print roller DR4S
	5954979.001	Print roller DR6S
2.5	5958631	Label sensor - reflective from top
2.6	5959622.001	Adapter 100
2.7	5561043	Memory card CompactFlash Type I
2.8	5954380	External operation panel
2.9	5946146	Pause adapter PS7
Pos.	Part no.	Interfaces
3.2	5954201	RS422/RS485
3.3	5948205	Label selection - I/O box
3.4	5561041	WLAN 802.11b/g
Pos.	Part no.	Connecting cable
4.1	5550818	Connecting cable RS232C 9/9 pin, length 3 m

Delivery program

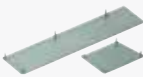
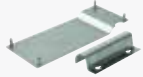
Pos.		Part no.	Label cutting, perforating, stacking
5.1		5948000 5948001 5948002	Cutter CU4 Cutter CU6 Cutter CU8
5.2		5960050.351 5960050.352	Perforation cutter PCU4/2,5 Perforation cutter PCU4/10
5.3		5541311 5541313	Stacker ST4 L with cutter Stacker ST4 M with cutter
		55xxxxx 55xxxxx	Support table ST4 L, label W x H Support table ST4 M, label W x H
Pos.		Part no.	Label rewinding, unwinding
6.1		5948100 5946090 5946420 5945804	External rewinder ER4/210 External rewinder ER4/300 External rewinder ER6/300 External rewinder ER8/300
6.3		5948170	Adapter kit for A8+
6.4		5965712 5965713	Adapter kit for XC4 Adapter kit for XC6

x - user specific part no. following request

Pos.		Part no.	Label software
		Bundle	cablabel S3 Lite (Download at cab.de/en)
		5588001 5588100 5588101 5588150 5588151 5588152	cablabel S3 Pro 1 WS cablabel S3 Pro 5 WS cablabel S3 Pro 10 WS cablabel S3 Pro 1 additional licence cablabel S3 Pro 4 additional licences cablabel S3 Pro 9 additional licences
11.7		5588002 5588105 5588106 5588155 5588156 5588157	cablabel S3 Print 1 WS cablabel S3 Print 5 WS cablabel S3 Print 10 WS cablabel S3 Print 1 additional licence cablabel S3 Print 4 additional licences cablabel S3 Print 9 additional licences
		in preparation	cablabel S3 Print Server
11.10		9008486	Programming manual EN, printed copy

Scopes of delivery, design and technical specifications correspond to the date of the printing. Subject to change. The data provided in the catalog do not represent any warranty or guarantee.



Information is also available on the Internet:
www.cab.de/en/labelprinter

Notes



cab product overview

Label printers
MACH1, MACH2



Label printers
EOS 2



Label printers
EOS 5



Label printers
MACH 4S



Label printers
SQUIX 2



Label printers
SQUIX 4



Label printers
SQUIX 6.3



Label printer
A8+



Label printer
XD4T



Label printers
XC



Print and apply systems
HERMES Q



Print and apply systems
Hermes C

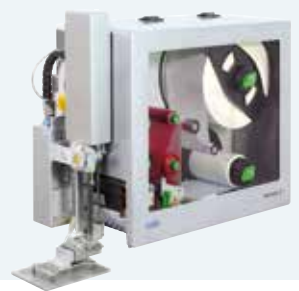

Tube labeling systems
AXON



Print modules
PX Q



Labels and ribbons



Label software
cablabel S3



Label dispensers
HS, VS



Labeling heads
IXOR



Marking lasers
XENO 4



Laser marking systems



Germany
cab Produkttechnik GmbH & Co KG
Karlsruhe
Phone +49 721 6626 0
www.cab.de

France
cab Technologies S.à.r.l.
Niedermodern
Phone +33 388 722501
www.cab.de/fr

USA
cab Technology, Inc.
Chelmsford, MA
Phone +1 978 250 8321
www.cab.de/us

Mexico
cab Technology, Inc.
Juárez
Phone +52 656 682 4301
www.cab.de/es

Taiwan
cab Technology Co., Ltd.
Taipei
Phone +886 (02) 8227 3966
www.cab.de/tw

China
cab (Shanghai) Trading Co., Ltd.
Shanghai
Phone +86 (021) 6236 3161
www.cab.de/cn

China
cab (Shanghai) Trading Co., Ltd.
Guangzhou
Phone +86 (020) 2831 7358
www.cab.de/cn

South Africa
cab Technology (Pty) Ltd.
Randburg
Phone +27 11 886 3580
www.cab.de/za

cab // 820 distribution partners in more than **80** countries

cab
we identify more